

Effects of Carbon Black on the Fatigue Life, Critical J-Value and Fracture Morphology and a New Estimated Equation for Natural Rubber

Kim Jae-Hoon*

*Korea Railroad Research Institute 360-1,
Woulam-Dong, Uiwang-City Kyonggi-Do 437-050, Korea*

Jeong Hyun-Yong

*Department of Mechanical Engineering, Sogang University
1 Shinsoo-Dong, Mapo-Gu, Seoul 121-742, Korea*

This study investigated the fatigue lives and mechanical properties of the carbon black filled natural rubber for the vibration-proof parts of the railway vehicle and automobile. The carbon blacks were one of the sources of crack nucleation and crack propagation in the rubber matrix, like the cementite and the manganese sulfide in iron matrix. Different kinds of carbon blacks resulted in different fatigue lives, critical J-values, and fracture morphologies. It was noticed that the critical J-value remained almost the same regardless of the length of a pre-crack. In addition, different kinds of carbon blacks generated different fracture morphologies, and microscopic and macroscopic roughnesses. The critical J-value has linear relations to the roughness, and it seemed related to the size distribution of carbon black particles. By reviewing all the experimental data, we found the factors that were related to the fatigue lives, and the logarithmic value of the fatigue life could be linearly expressed by the combination of the critical J-value and the macroscopic roughness. We also proposed a new estimative equation of fatigue life.

Key Words : Fatigue Life, Carbon Black, Natural Rubber, Fracture Morphology, Critical J-value

1. Introduction

The fracture of materials has been investigated by two kinds of major methods. One method finds out the reasons of decohesion between matrix and fillers.(Argon and Im, 1975) The other method studies the stress field and the strain field numerically and investigates the crack propagation, when there are cracks on matrix.(Kanninen and Popelar, 1985) These two

methods are complementary to each other. For example, the cementite and the manganese sulfide cause the decohesion between these and iron matrix during the deformation process, and the decohesion makes a void.(Argon and Im, 1975) Voids are connected with each other; this mechanism is called void sheet mechanism, so that the crack and crack propagation are induced on the iron matrix. And finally the material is fractured.(Cox and Low, 1974) These processes are found in aluminum composites and polymer composites frequently.(Sawyer and Grubb, 1996) Carbon black is the general reinforcement to increase strength of rubber. However, carbon black is not as easily deformed as rubber and the strain of rubber around carbon black increases. Young's modulus of carbon black is

* Corresponding Author,
E-mail : lapin95@krri.re.kr
TEL : +82-31-461-5248; FAX : +82-31-460-5279
Korea Railroad Research Institute 360-1, Woulam-Dong, Uiwang-City Kyonggi-Do 437-050, Korea.
(Manuscript Received July 22, 2003; Revised March 24, 2004)

larger than the rubber's modulus. If a large or repeated force is applied on the rubber compound, carbon black is decohered from rubber. As a result, the void is produced and it becomes the micro-crack that leads to fracture due to void sheet mechanism. (Sawyer and Grubb, 1996) When carbon black is filled in rubber compound for the reinforcement, the characteristics of decohesion between carbon black and rubber matrix need to be taken into account. For this purpose, many researchers have taken various approaches. Greensmith (1956) researched the forming of reinforcement mechanism caused by carbon black to find the basic reasons of decohesion between the carbon black and the rubber through the micro morphological viewpoint. By the tensile test, he also found out that the effect of reinforcement of carbon black occurred only in limited temperature and strain ranges. Hess and Ford (1963) showed by the TEM that the dispersion of carbon black in rubber matrix is different depending on the shape and size of carbon black.

When the crack is in rubber materials, Rivlin (1953) and Mathew (1982) studied the tearing mechanism due to the carbon black in order to find out the variation of crack growth by the fields of the stress and strain around the crack. Especially, Gent and Pulford (1984) researched the crack propagation and crack propagation process in the matrix filled up with carbon black.

These previous studies were conducted based on either the micro morphological viewpoint or mechanical viewpoint; but no integrated research was found. Recognizing such limitations of previous researches, we studied both the micro morphological viewpoint and mechanical viewpoint, the fatigue life, critical J-value ($=J_c$), and fracture morphology, by using carbon black, N330, N650 and N990, filled in natural rubber compound. Natural rubber is commonly used for the vibration-proof parts of the railway vehicle and automobile. In addition, the correlation of the critical J-value and the fracture morphology were investigated. The correlation of the logarithmic value of the fatigue life and the combination of the critical J-value and the fracture

morphology was discussed. Also we proposed a new estimated equation of fatigue life.

2. Experiments

2.1 Materials

2.1.1 The natural rubber and carbon black

We used the natural rubber as a basic material for experiments. Table 1 shows that the characteristics of natural rubber compound and different kinds of carbon blacks. The carbon blacks were classified into the small, middle, large sizes by ASTM standard D1765-95a (standard classification system for carbon black) and representative carbon blacks for each size were selected. The amounts of carbon black in each compound were determined based on a 62 IRHD (International Rubber Hardness Degree). This hardness is the requirement on the mechanical property of the vibration-proof rubber for the vehicle.

2.2 Experimental methods

2.2.1 Measurement of the fatigue life

The specimen of hourglass shape, proposed by K. Takeychi (1993), was used to measure the fatigue lives of the natural rubber, as shown in Figure 1. It has an elliptical cross section, and the seam line is located on the surface of the minor axis. Since the stress on the surface of the major axis is higher than that on the surface of the minor axis, a crack usually starts at the major axis, and

Table 1 The characteristic of natural rubber and carbon black

	N330	N650	N990
CB particle dia. (nm)	30	61	285
Specific weight	1.1245	1.1485	1.2270
CB phr	46	54	90
Volume fraction (%)	16.8	18.4	28.0
Total phr	171.26	183.00	219.26
Curing Time (sec)	420	420	420
Curing Temp. (°C)	173	173	173
IRHD	62	62	62

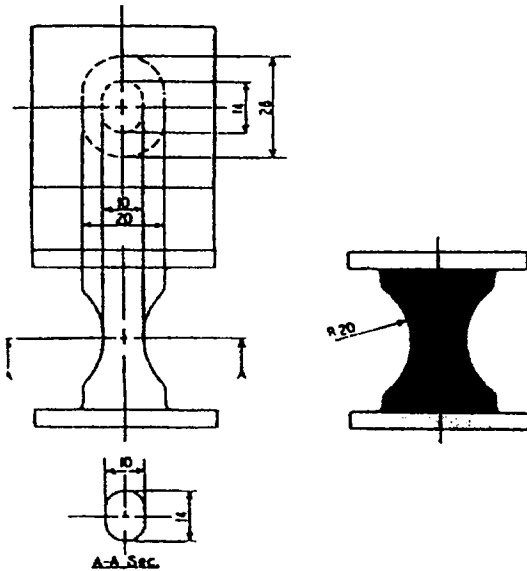

Fig. 1 The hourglass shape fatigue life test specimen

the seam line hardly affects the fatigue life of the specimen. The fatigue lives were tested in the room temperature, 23°C, by using MTS 810. At this time, the specimen was cooled by the compressed room temperature air to keep the surface temperature at 23°C. The frequency was 1 Hz sinusoidal wave. The amplitudes were as each 16 mm, 19 mm and 22 mm in test. The fatigue life was defined to be the cycle at which the load became half the load measured at 10,000 cycles.

2.2.2 Measurement of the critical J-value

The critical J-values were measured by the method of Begley and Landes.(1972) The dumbbell specimens were used for the tests, as shown in Figure 2.(ASTM D412-92, 1996). For each type of natural rubber compound, a set of five specimens were pre-cracked, the crack length ranging from 1 mm to 3 mm, every 0.5 mm apart. The loading speed of the tensile test was 500 mm/min, standard velocity in ASTM, by using a Universal Test Machine. The force [N] and the displacement [mm] were plotted. The area under a given plot is equal to the energy [Nmm]. Therefore, this plot is translated to the energy and pre-crack plot. From the energy and pre-

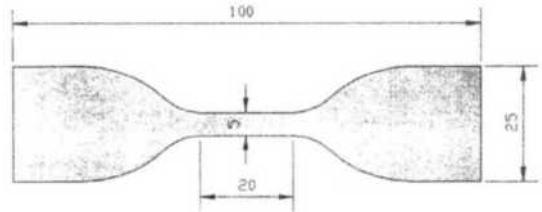

Fig. 2 The dumbbell shape tensile test specimen.

crack plot, the differential values are calculated and the function is made on it. This function is defined as J-Integral. While the specimen was being loaded, it was video-recorded by a digital motion camera. The moment when the geometry around the crack became asymmetric with respect to the crack surface was regarded as the moment of the crack growth (Goldberg and Lesuer, 1988), and the J-value at the moment was assumed to be the critical J-value.

2.2.3 Measurement of the fracture morphology

In general, fracture surface morphologies give information about failure processes and mechanisms, but the fracture surfaces morphology of the fatigue test is quite rough. The stereo optical microscope that had the poor depth of focus could not be used for the analysis of this fracture surface. Instead, the microscope for the inspection of semiconductor (LG DSP color camera) that had the good depth of focus was used for the analysis of fracture surface that depended on the grade of carbon black.(From X100 to X1000) To measure the fracture surface statistical parameters, the root-mean-square (rms) roughness method was employed by a stylus type roughness tester. However, the rms roughness was calculated in two different scales. The profile along the major axis of 14 mm long was obtained, and the rms roughness was calculated for the profile. This roughness was named the macroscopic roughness in this paper. The profiles of 0.5 mm~4 mm long segments along the major axis were obtained, and the rms roughness for the profile was assumed to be the average of the roughness of the segments. Specially, the roughness that was measured by 1 mm was named the microscopic

roughness.

2.2.4 Investigation on the carbon black distribution

The sample sheets, were taken from the specimens after fatigue tests, were made by using the glass knife in liquid nitrogen. These sheets were examined with optical microscope. There are 10,000 cells in 1 mm² area on a sheet. The three places were randomly chosen on each sheet and were examined to see the carbon black distribution. Also the numbers and diameters of carbon black agglomerates whose size was more than 50 μm² were measured on the same places.

3. Results and Discussion

3.1 Change of physical properties for the carbon black filled natural rubbers

3.1.1 Change of fatigue life

Table 2 shows the fatigue life of the natural rubber compounds obtained from three amplitudes, 16 mm, 19 mm and 22 mm. The fatigue lives of natural rubber compound are different by each type of carbon black. The N330 carbon black filled natural rubber had the longest fatigue lives, but N650 carbon black filled natural rubber had the shortest. These results came from the change of physical properties according to different kinds of carbon blacks in the same matrix. The change of properties is thoroughly explained in the next sections.

Table 2 The fatigue life of the natural rubber compounds [cycle]

	N330	N650	N990
22 mm	375,723	40,023	200,375
	387,927	41,215	228,371
	382,978	42,089	214,271
19 mm	482,463	92,347	317,823
	490,159	106,617	328,741
	469,328	97,812	325,017
16 mm	617,134	180,165	462,172
	632,471	248,461	449,638
	627,807	213,199	460,116

3.1.2 Change of tear energy

Polymer materials including the natural rubber could start the fracture under the low stress than the original strength due to internal cracks or surface cracks. The crack growth caused this fracture and it also was related to carbon black in natural rubber compound. Therefore, the critical J-value was used in order to find out the characteristic for the crack growth in the natural rubber due to different kinds of carbon blacks. As equation (1), the parameter J-Integral that was made by Rice (1968) characterizes the crack growth propagation behavior of non-linear materials.

$$J = -\frac{1}{B} \left(\frac{\partial U}{\partial a} \right)_{\Delta} \tag{1}$$

Here, *U* is the strain energy, *a* is the length of pre-crack, *B* is the thickness of tensile specimen, and Δ is the displacement. Especially the critical J-value means the fracture energy for increasing the unit area of crack when the crack starts to grow, like tear energy. (Begley and

Table 3 The critical J-value of carbon black filled natural rubber [N/mm]

	Precrack	N330	N650	N990
1 set	1.0	1.41680	0.38901	1.19705
	1.5	1.43125	0.36965	1.15925
	2.0	1.42570	0.37848	1.16175
	2.5	1.40130	0.39805	1.17235
	3.0	1.41020	0.40244	1.19315
	Ave.	1.41705	0.38752	1.17671
2 set	1.0	1.43247	0.37984	1.18641
	1.5	1.40586	0.38549	1.17546
	2.0	1.41357	0.38451	1.13684
	2.5	1.42647	0.37985	1.16789
	3.0	1.41957	0.39015	1.19807
	Ave.	1.41959	0.38397	1.17293
3 set	1.0	1.41854	0.39126	1.16124
	1.5	1.40251	0.38991	1.13573
	2.0	1.43546	0.32541	1.20254
	2.5	1.40507	0.35790	1.08654
	3.0	1.39875	0.36281	1.17315
	Ave.	1.41207	0.36532	1.15184

Landes, 1972 ; Lee, 1987) Large critical J-value means more energy is needed to starts crack and then it takes long time until crack growth begins under the constant velocity. In this result, the critical J-value of natural rubber, like N330 carbon black filled natural rubber in Table 3, is large and it dose not break out the fracture easily. However, the critical J-value of N650 carbon black filled natural rubber, is small and it breaks out by fracture easily. It means that the toughness reduces in the materials. As Table 3 shows, the critical J-value of natural rubber varies depending on the kind of carbon blacks. When the critical J-value is measured, the characteristic of fracture of rubbers in crack-tip could be confirmed. However, the critical J-value was almost the same regardless of the length of the pre-crack in the same matrix.

3.2 Fracture morphology due to different kinds of carbon blacks

3.2.1 Change of fracture morphology

In general, fracture surface morphologies give information about failure processes and mechanisms (Sawyer and Grubb, 1996) . As shown in Figure 3, the macro-scale (=low power) fracture morphologies of the three types of natural rubber compounds look quite rough. While the natural rubber compound filled with N330 or N990 shows little difference between the pick and valley in the surface, but the natural rubber compound filled with N650 shows a big difference. These results become clearer through the macroscopic roughness test of fracture surface, as shown in Table 4. The values of macroscopic roughness could be arranged as N650>N990>N330 with different kinds of carbon blacks.

Note that the fracture surface morphologies of the length below 1 mm were different from the macro-scale, so we decided that the fracture surface morphologies of 1 mm length were micro-scale fracture morphologies. Figure 4 shows that the micro-scale (=high power) fracture morphologies of the natural rubber compound filled with N330 or N990 are very rough. But in case of N650 carbon black, the micro-scale fracture surfaces are smooth. Hence, the microscopic roughness shows the opposite result from the macroscopic roughness, as shown in Table 5.

Table 4 Macroscopic roughness data [mm]

	N330	N650	N990
1 set	0.3133	0.7956	0.3640
2 set	0.3226	0.7738	0.4173
3 set	0.2981	0.7429	0.4946

Table 5 Microscopic roughness data [mm]

	N330	N650	N990
1 set	0.14970	0.03365	0.04433
	0.12269	0.01868	0.09049
	0.04836	0.03309	0.02921
	0.05483	0.03444	0.03561
Ave.	0.09390	0.02997	0.04991
2 set	0.12589	0.03754	0.03842
	0.04865	0.03153	0.05879
	0.11254	0.01946	0.02215
	0.09123	0.02679	0.04246
Ave.	0.09458	0.02883	0.04046
3 set	0.15397	0.03811	0.03992
	0.11439	0.01772	0.04817
	0.06115	0.01839	0.04003
	0.05437	0.02115	0.05234
Ave.	0.09597	0.02384	0.04512

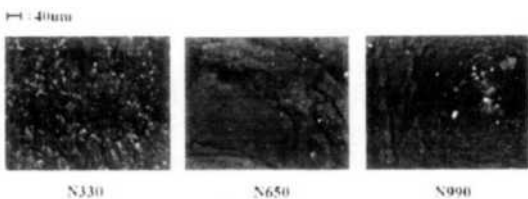

Fig. 3 Macro-scale fracture surface morphology

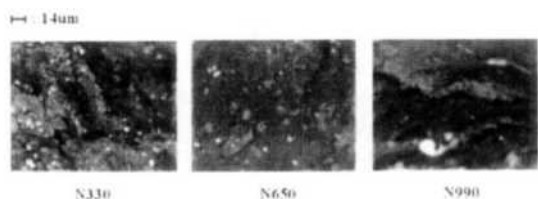

Fig. 4 Micro-scale fracture surface morphology

The values of microscopic roughness could be arranged as N330 > N990 > N650 with different kinds of carbon blacks. From these results, N330 and N990 carbon blacks appear to have acted as a local stress raiser and dispersed the direction of crack process, which results in the rough surface in micro-scale. These processes are called the Knotty tearing (Lee, 1987). The fracture energy well spread and the differences between the pick and valley are increased in macro-scale. However, the rubber compound filled with N650 had a clean surface in the micro scale. That means that the carbon black, N650, formed large agglomerates that were easily separated from the rubber matrix. Thus, a crack propagated rapidly creating a cleaner surface in the micro-scale. As a result, the fracture morphologies of the natural rubber change with the kind of carbon blacks, but the fracture morphology of the carbon black that filled up natural rubber must be divided into the macro and micro-scale. Also the knotty tearing is related to decohesion between the carbon black and the rubber as well as the critical J-value. These are carefully explained in the next section.

3.2.2 Relation between the fracture morphology and the critical J-value

The fracture morphology must be divided into the macro and micro-scale. The macro-scale roughness in the natural rubber compound is inversely proportional to the critical J-value according to different kinds of carbon blacks filled, as shown in Fig. 5. The larger the macroscopic roughness in the natural rubber becomes, the smaller critical J-value is. However, when the microscopic roughness in the natural rubber is large, the critical J-value is large, too, as shown in Figure 6. But, as shown in the Figures 5 and 6, the correlation coefficients ($=r^2$) of the macroscopic roughness is higher than those of the microscopic roughness, so the microscopic roughness is more proper to the critical J-value.

The degree of carbon black dispersion was measured in order to find out the reason of linear relation. As the result, the carbon black agglomerate in the compound appeared to be normally

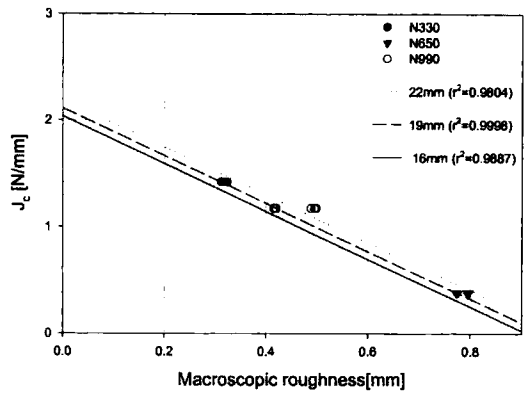

Fig. 5 Linear correlation between critical J-value and macroscopic roughness

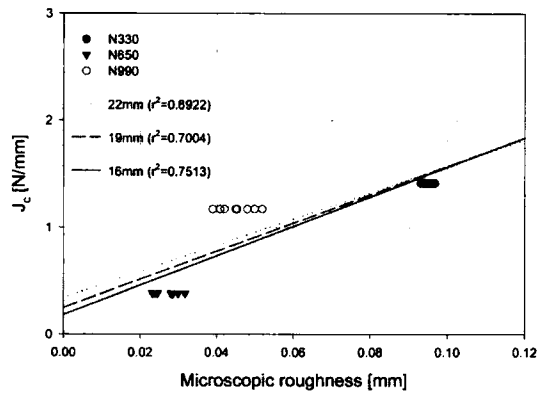

Fig. 6 Linear correlation between critical J-value and microscopic roughness

distributed in Table 6. These are the percent that the carbon blacks exist on the cell per 10,000 cells in 1 mm² area of rubber matrix. But the diameter and quantities of carbon black agglomerate whose sizes were 50 μm² or more varied depending on the kind of carbon blacks, as shown in Fig. 7. It was found that the big size and large number of carbon black agglomerate, like the N650 carbon black lead to the decrease in the critical J-value. In other words, if the carbon black agglomerate is big or is combined into large size, it works like the filler, the roll of reinforcement, basic purpose, is weakened. (Gent and Pulford, 1984) Further more, when the cracks grow at the crack-tip, N650 carbon black is easily separated from the matrix by a little

Table 6 Carbon black existing percent on the cell per 10,000 cells in 1 mm² area of rubber matrix

	N330	N650	N990
1	99.90%	98.10%	98.40%
2	99.70%	96.90%	97.80%
3	99.70%	97.20%	97.70%
Ave.	99.77%	97.40%	97.40%

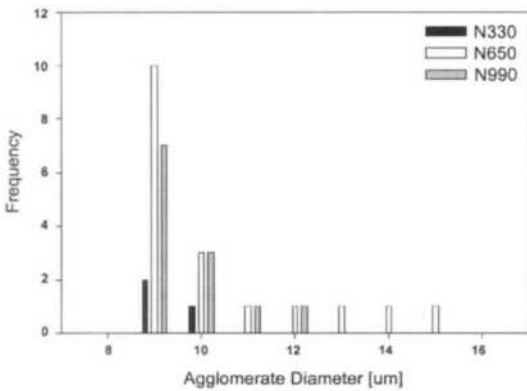

Fig. 7 Carbon black frequency and agglomerate diameter in natural rubber matrix

energy. Because the carbon black and the matrix are easily separated in the crack propagation process, this process is interrupted less and the knotty tearing decreases. Therefore, the crack propagates rapidly, the critical J-value falls down, and the microscopic roughness becomes low. But it was found that the small size and a few numbers of carbon black agglomerate like N330 carbon black in which the critical J-value is high and microscopic roughness becomes large.

From these facts, the relation of the critical J-value to the fracture surface roughness could be made by the size and quantity dispersion of carbon black agglomerate.

3.3 Relation between the energy and fatigue life due to different kinds of carbon blacks

3.3.1 New estimated equation of fatigue life

The relations between the morphological results and the mechanical results due to different

kinds of carbon blacks were found out by reviewing all the experimental data. The relation between the fatigue lives in rubber, which was one of the most interesting things in the mechanical properties, were examined. From the result, the fatigue lives are proportional to the critical J-value, J_c , and are inversely proportional to the macroscopic roughness.

Especially the logarithmic value of the fatigue lives could be linear, like the equation (2), by the combination of the critical J-value and the macroscopic roughness on the each test amplitude.

$$\log(N_f) = A \left[\frac{J_c/EL}{\eta} \right] + B \quad (2)$$

Here, E and L are used for the dimensionless. E is the Young's modulus. When the rubber has the hardness between 30 and 85 IRHD, the logarithmic value of Young's modulus, $\log(E)$, is related to IRHD. (Hawley, 1997; ASTM D1415-88, 1996) Different kinds of carbon blacks that filled up natural rubber specimens have the same hardness, 62 IRHD. Therefore, Young's modulus is 3.8734 [N/mm²]. L is the width of fracture region, $L=5$ mm, in tensile test specimen, because the thickness in the tensile specimen is related to the critical J-value. The length of pre-crack is almost the same regardless of the critical J-value and η is the value of the macroscopic roughness. However, when the coefficients A and B are compared with the fatigue test amplitudes D ($=22$ mm, 19 mm, 16 mm), the coefficients A and B change consistently with amplitudes D in Table 7. So these changes could be expressed linearly to amplitudes D , like the equations (3) and (4), and each equation could be combined into the one general equation.

$$A = a + D \times b \quad (3)$$

$$B = c + D \times d \quad (4)$$

If the equations (3) ~ (4) are substituted in equation (2), the general equation of fatigue life is expressed as equation (5) and the results are shown in Fig. 8.

$$\log(N_f) = (a + D \times b) \left[\frac{J_c/EL}{\eta} \right] + (c + D \times d) \quad (5)$$

Table 7 Values of coefficient A and B

Amplitude	A	B
22 mm	4.782	4.579
19 mm	3.352	4.944
16 mm	2.155	5.284

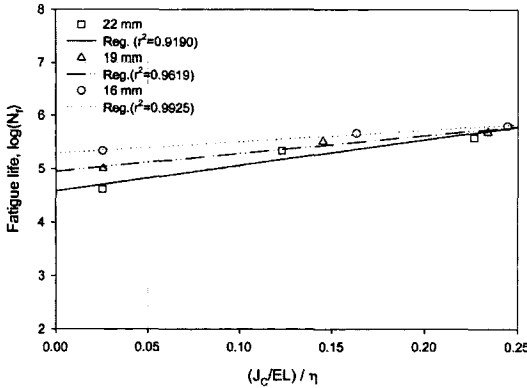

Fig. 8 Linear correlation between $\log(N_f)$ and $[(J_c/EL)/\eta]$

The calculation results also agree with the experimental results, and both results are very similar for the correlation coefficients 0.9 in Figure 8. Therefore the logarithmical fatigue lives of carbon black that filled up natural rubber could be linearly expressed by the combination of the critical J-value and the macro-scale fracture surface roughness like equation (5). Following this result, if the critical J-value and the macroscopic roughness could be measured for new kinds of carbon blacks that filled up natural rubber, the fatigue lives could be estimated.

4. Conclusion

We find out the following conclusions about the natural rubber compound filled up with N330, N650 and N990 carbon black.

(1) The fatigue lives of natural rubber change by different kinds of carbon blacks.

$$(N330 > N990 > N650)$$

(2) The crack growth is affected by the carbon black. When the crack starts to grow, the critical J-value describes the fracture energy needed to increase the unit area of cracks. However, the

critical J-value is almost the same regardless of the length of a pre-crack in the same matrix.

(3) The fracture morphologies of the natural rubber change due to different kinds of carbon blacks. However, it must be divided into the macro-scale and micro-scale.

(4) The new relation between the fracture morphology and the critical J-value was found. The critical J-value could be linearly expressed by the micro-scale fracture morphology, but they are inversely proportional to the macroscopic roughness. This relation could be made by the size and quantity dispersion of carbon black agglomerate.

(5) The logarithmical fatigue lives of carbon black that filled up natural rubber could be linearly expressed by the combination of the critical J-value and the macroscopic roughness, and the coefficients A and B also change linearly with amplitude D.

$$\log(N_f) = (a + D \times b) \left[\frac{(J_c/EL)}{\eta} \right] + (c + D \times d)$$

Acknowledgment

This work was supported in the National Research Laboratory program, and we thank Korea Ministry of Science and Technology for the supporting.

References

ASTM D1415-88, 1996, "Standard Test Method for Rubber Property-International Hardness," *Annual book of ASTM standard*, pp. 234~237.

ASTM D412-92, 1996, "Standard Test Methods for Vulcanized Rubber and Thermoplastic Rubbers and Thermoplastic Elastomers-Tension," *Annual book of ASTM standard*, pp. 41~53.

Argon, A. S. and Im, J., 1975, "Separation of Second Phase Particles in Spheroidized 1045 Steel, Cu-0.6pct Cr Alloy, and Maraging Steel in Plastic Straining," *Metallurgical Transactions*, 6A, pp. 839~851.

Begley, J. A. and Landes, J. D., 1972, The J-

Integral as a Fracture Criterion, ASTM STP 514. American Society for Testing and Materials, Philadelphia, pp. 1~20.

Cox, T. B. and Low, J. R., 1974, "An Investigation of the Plastic Fracture of AISI 4340 and 18 Nickel-200 Grade Maraging Steels," *Metallurgical Transactions*, 5, pp. 1457~1470.

Gent, A. N. and Pulford, C. T. R., 1984, "Micro-mechanics of Fracture in Elastomers," *Journal of Materials Science*, 19, pp. 3612~3619.

Goldberg, A. and Lesuer, D. R., 1988, "Observations Made During Stretching, Tearing, and Failure of NR and SBR Loaded with Various Amounts of Carbon Black," *Rubber Chemistry and Technology*, pp. 288~304.

Greensmith, H. W., 1956, "Tear Properties of Vulcanizates Containing Carbon Black," *Journal of Polymer Science*, 21, pp. 175~187.

Hawley, S. W., 1997, "Anomalies in ISO 48, Hardness of Rubber," *Polymer Testing*, 16, pp. 327~333.

Hess, F. M. and Ford, F. P., 1963, "Microcopy of Pigment-Elastomer Systems," *Rubber Chemistry and Technology*, 36, pp. 1175~1228.

Kanninen, M. F. and Popelar, C. H., 1985,

Advanced Fracture Mechanics, Oxford Science Publications.

Lee, D. J., 1987, *Fracture, Aging and Microstructural Changes in Carbon Black Filled Natural Rubber*, Ph. D. Thesis, University of Massachusetts, pp. 108~120.

Mathew, N. M., Bhowmick, A. K. and De, S. K., 1982, "Chemical and Scanning Electron Microscopy Studies on Fatigue Failure of Natural Rubber," *Rubber Chemistry and Technology*, 55, pp. 51~61.

Rice, J. R., 1968, "A Path Independent Integral and the Approximate Analysis of Strain Concentration by Notches and Cracks," *Journal of Applied Mechanics*, 35, pp. 379~386.

Rivlin, R. S. and Thomas, A. G., 1953, "Characteristic Energy for Tearing," *Journal of Polymer Science*, 10, pp. 291~318.

Sawyer, L. C. and Grubb, D. T., 1996, *Polymer Microscopy, 2nd Edit*, Chapman & Hall.

Takeychi, K., Nakagawa, M., Yamaguchi, H. and Okumoto, T., 1993, "Fatigue Test Technique of Rubber Materials for Vibration Insulators and Their Evaluation," *International Polymer Science and Technology*, 20(10).